

---

**PFAFF**<sup>®</sup>

**145**

**Unterklassen-Ausstattung**  
Subclass parts  
Composition des sous-classes  
Composición de las subclases

Unterklassen-Ausstattung<sup>1)</sup>

Subclass Organization<sup>1)</sup>

Equipement des sous-classes<sup>1)</sup>

Dotación de las subclases<sup>1)</sup>

Unterklasse Subclass Sous-classe Subclase	Ausführung Model Version Tipo de máquina	Nadeistange Needle bar Barre à aiguille Barra de aguja	Stoffschieber <sup>1)</sup> Feed dog Griffe Transportador inferior	Stichplatte <sup>1)</sup> Needle plate Plaque à aiguille Placa de aguja	Nähfuß <sup>1)</sup> Presser foot Pied presseur Pie prensateelas	Stoffschieberfuß <sup>1)</sup> Vibrating presser Pied entraîneur Transportador superior
-2/01**	B, BN	91-710 650-92	91-040 444-04 <sup>1272</sup>	91-040 445-04 <sup>1272</sup>	91-040 234-04 <sup>1272</sup>	91-040 233-93 <sup>1272</sup>
<sup>12)</sup> = 1,8-4,0 mm						
-6/01*	B, BN	91-710 650-92	91-026 745-04	91-026 746-04	91-040 475-04 <sup>1272</sup>	91-040 474-93 <sup>1272</sup>
-17/01	B, BN	91-710 650-92	91-045 591-04	91-045 592-04	91-040 432-04 <sup>1272</sup>	91-042 819-93 <sup>1272</sup>
-17/41	B, BN	91-710 650-92	91-040 897-04	91-040 898-04	91-040 475-04 <sup>1272</sup>	91-040 474-93 <sup>1272</sup>
-17/43*	B, BN	91-710 650-92	91-026 745-04	91-026 746-04	91-049 514-04 <sup>5)</sup>	91-049 021-93 <sup>5)</sup>
-19/01*	B, BN	91-710 650-92	91-026 745-04	91-026 746-04	91-040 475-04 <sup>1272</sup>	91-040 474-93 <sup>1272</sup>
-19/02*	B, BN	91-710 650-92	91-026 745-04	91-026 746-04	91-040 475-04 <sup>1272</sup>	91-040 474-93 <sup>1272</sup>
-39/01	B, BN	91-710 650-92	91-045 591-04	91-045 592-04	91-040 432-04 <sup>1272</sup>	91-042 819-93 <sup>1272</sup>
-39/21	B, BN	91-710 650-92	91-045 591-04	91-045 592-04	91-044 227-04 <sup>1272</sup>	91-042 819-93 <sup>1272</sup>
-39/22	B, BN	91-710 650-92	91-045 591-04	91-045 592-04	91-044 227-04 <sup>1272</sup>	91-042 819-93 <sup>1272</sup>
-39/41	B, BN	91-710 650-92	91-040 897-04	91-040 898-04	91-040 475-04 <sup>1272</sup>	91-040 474-93 <sup>1272</sup>
-39/81	B	91-710 650-92	91-047 399-04	91-048 924-04	91-040 432-04 <sup>1272</sup>	91-042 819-93 <sup>1272</sup>
-40/11**	B, BN	91-710 650-92	91-040 444-04 <sup>1272</sup>	91-040 445-04 <sup>1272</sup>	91-044 227-04 <sup>1272</sup>	91-042 819-93 <sup>1272</sup>
-40/41*	B, BN	91-710 650-92	91-026 745-04	91-026 746-04	91-040 475-04 <sup>1272</sup>	91-040 474-93 <sup>1272</sup>
-40/61**	B, BN	91-710 650-92	91-040 444-04 <sup>1272</sup>	91-040 445-04 <sup>1272</sup>	91-044 227-04 <sup>1272</sup>	91-042 819-93 <sup>1272</sup>
-42/02*	B, BN	91-710 650-92	91-026 745-04	91-026 746-04	91-046 342-04 <sup>1272</sup>	91-040 461-93 <sup>1272</sup>
-95/04	B, BN	91-710 650-92	91-045 591-04	91-045 592-04	91-044 227-04 <sup>1272</sup>	91-042 819-93 <sup>1272</sup>
-136/02*	B, BN	91-710 650-92	91-026 745-04	91-026 746-04	91-049 514-04 <sup>5)</sup>	91-049 021-93 <sup>5)</sup>
-155/01	B, BN	91-710 650-92	91-045 591-04	91-045 592-04	91-040 432-04 <sup>1272</sup>	91-042 819-93 <sup>1272</sup>
-155/21	B, BN	91-710 650-92	91-045 591-04	91-048 360-04	91-044 227-04 <sup>1272</sup>	91-042 819-93 <sup>1272</sup>
-155/41	B, BN	91-710 650-92	91-040 897-04	91-040 898-04	91-040 475-04 <sup>1272</sup>	91-040 474-93 <sup>1272</sup>
-167/02*	B, BN	91-710 650-92	91-026 745-04	91-026 746-04	91-040 475-04 <sup>1272</sup>	91-040 474-93 <sup>1272</sup>
-168/02*	B, BN	91-710 650-92	91-026 745-04	91-026 746-04	91-042 180-04 <sup>5)</sup>	91-042 181-93 <sup>5)</sup>
-195/02*	B, BN	91-710 650-92	91-026 745-04	91-026 746-04	91-040 475-04 <sup>1272</sup>	91-040 474-93 <sup>1272</sup>
-195/04	B, BN	91-710 650-92	91-045 591-04	91-045 592-04	91-044 227-04 <sup>1272</sup>	91-042 819-93 <sup>1272</sup>
-226/02*	B, BN	91-710 650-92	91-026 745-04	91-026 746-04	91-046 719-04 <sup>5)</sup>	91-046 720-93 <sup>5)</sup>
-248/02*	B, BN	91-710 650-92	91-026 745-04	91-026 746-04	91-046 656-04	91-046 657-93

\* Unterklasse kann mit Fadendurchzieh- und Fadenabschneid-Einrichtung -900/11;/16;/51;/56 geliefert werden, wobei sich die Nummer des Stoffschiebers von 91-026 745-04 in 91-047 822-04 und die Nummer der Stichplatte bei -900/11 und /51 von 91-026 746-04 in 91-058 420-05 bzw. bei -900/16 und /56 von 91-026 746-04 in 91-058 939-05 ändert.

\* Subclass can be supplied with thread puller/trimmer -900/11;/16;/51;/56, in which case feed dog No. 91-026 745-04 is replaced by No. 91-047 822-04, and with -900/11 and /51 needle plate No. 91-026 746-04 is replaced by No. 91-058 420-05, and with -900/16 and /56 needle plate No. 91-026 746-04 is replaced by No. 91-058 939-05.

\*\* Unterklasse kann mit Fadendurchzieh- und Fadenabschneid-Einrichtung -900/11 und /51 geliefert werden, wobei sich die Nummer der Stichplatte von 91-040 445 in 91-058 422-04 ändert.

\*\* Subclass can be supplied with thread puller/trimmer -900/11 and /51, in which case needle plate No. 91-040 445-04 is replaced by No. 91-058 422-04.

<sup>1)</sup> = Ausführung angeben  
= Indicate model  
= Préciser la version  
= Indicar el tipo de máquina

<sup>5)</sup> = Nähmuster einsenden  
= Submit sewing sample  
= Joindre échantillons de couture  
= Enviar muestra de costura

<sup>12)</sup> = Absteppbreite angeben  
= Indicate stitching margin  
= Indiquer le relarge de couture  
= Indiquese el margen de costura

<sup>1272</sup> = Absteppbreite bei Bestellung angeben  
= Indicate stitching margin on order  
= Indiquer le relarge de couture à la commande  
= Indiquese el margen de costura en los pedidos

**Equipement des sous-classes<sup>1)</sup>**  
**Unterklassen-Ausstattung<sup>1)</sup>**

**Dotación de las subclases<sup>1)</sup>**  
**Subclass organization<sup>1)</sup>**

Sous-classe Subclase	Ausführung Modell Version Tipo de máquina	Apparat (S) Attachment Appareil Aparato	Träger Bracket Support Soporte	Halterwinkel Bracket Equerre de retenue Soporte angular	Kopfplatte Face plate Plaque frontale Placa frontal	Lineal Edge guide Guide-droit Guia recta	Bandhalter Tape edge Plaque dérouleur Disco portachitas	Bandrollhalter Tape reel bracket Support de plateau dérouleur Portarrollos	Fingerschutz Finger guard Protège-digits Salvadedos
01**	B, BN			91-025 559-25		91-040 998-25			91-055 203-5
= 1,8-4,0 mm									
01*	B, BN								91-055 203-5
7/01	B, BN	91-040 533-23	91-045 607-90				91-043 943-91		91-055 203-5
7/41	B, BN	91-041 111-23	91-040 528-90				91-043 943-91		91-055 203-5
7/43*	B, BN	91-053 132-25	91-040 528-90						91-055 203-5
7/01*	B, BN	91-041 006-23	91-040 528-90						91-055 203-5
9/02*	B, BN	91-044 408-23	91-040 528-90						91-055 203-5
9/01	B, BN	91-041 969-25	91-045 607-90				91-043 943-91		91-055 203-5
9/21	B, BN	91-041 382-23	91-045 607-90				91-043 943-91		91-055 203-5
9/22	B, BN	91-046 265-25	91-045 607-90				91-043 943-91		91-055 203-5
9/41	B, BN	91-041 113-23	91-040 528-90				91-043 943-91		91-055 203-5
9/81	B	91-053 674-23	91-040 528-90				91-043 943-91		91-055 203-5
0/11**	B, BN	91-053 676-25	91-042 940-90 ○⊗						91-055 203-5
0/41*	B, BN	91-053 257-93	91-042 940-90 ○⊗						91-055 203-5
0/61**	B, BN	91-046 331-24	91-042 940-90 ○⊗						91-055 203-5
2/02*	B, BN	91-040 638-23	91-040 528-90						91-055 203-5
5/04	B, BN	91-041 959-23	91-045 607-90						91-055 203-5
36/02*	B, BN	91-053 078-23	91-040 528-90						91-055 203-5
55/01	B, BN	91-040 600-23	91-045 607-90				91-043 943-91		91-055 203-5
55/21	B, BN	91-043 921-24	91-045 607-90				91-043 943-91		91-055 203-5
55/41	B, BN	91-041 112-23	91-040 528-90				91-043 943-91		91-055 203-5
67/02*	B, BN	91-042 099-23	91-040 528-90						91-055 203-5
68/02*	B, BN	91-042 179-23	91-040 528-90						91-055 203-5
95/02*	B, BN	91-040 798-23	91-040 528-90						91-055 203-5
95/04	B, BN	91-041 991-25	91-045 607-90						91-055 203-5
26/02*	B, BN	91-046 721-25	91-040 862-90		91-010 702-91			91-043 938-91	91-055 203-5
48/02*	B, BN	91-046 653-21	91-042 940-90 ○⊗						91-055 203-5

\* Sous-classe livrable avec coupe-fil -900/11;/16;/51 ou /56, avec remplacement de la griffe n° 91-026 745-04 par celle n° 91-047 822-04 et de la plaque à aiguille, en ss-cl. -900/11 et /51, n° 91-026 746-04 par celle, n° 91-058 420-05, respect., en ss-cl. -900/16 et /56, n° 91-026 746-04 par celle, n° 91-058 939-05.

\* La subclase puede suministrarse con cortahilos -900/11;/16;/51;/56 en cuyo caso se sustituye el transportador inferior N° 91-026 745-04 por el del N° 91-047 822-04 y la placa de aguja, en -900/11 y /51, N° 91-026 746-04 por la del N° 91-058 420-05, y en -900/16 y /56, el N° 91-026 746-04 se sustituye por el 91-058 939-05.

\*\* Sous-classe livrable avec coupe-fil -900/11 ou /51, avec remplacement de la plaque à aiguille n° 91-040 445-04 par celle, n° 91-058 422-04.

\*\* La subclase puede suministrarse con cortahilos -900/11 y /51, en cuyo caso la placa de aguja N° 91-040 445-04 se sustituye por la del N° 91-058 422-04.

91-710 650-92

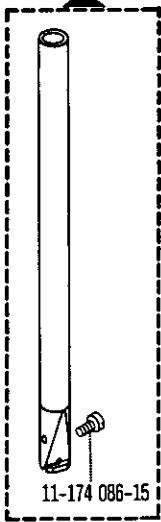

- 2/01
- 2/01-900/11; /51
- 6/01
- 6/01-900/..
- 17/01
- 17/41
- 17/43
- 17/43-900/..
- 19/01
- 19/01-900/..
- 19/02
- 19/02-900/..
- 39/01
- 39/21
- 39/22
- 39/41
- 39/81
- 40/11
- 40/11-900/11; 51
- 40/41
- 40/41-900/..
- 40/61
- 40/61-900/11; /51
- 42/02
- 42/02-900/..
- 95/04
- 136/02
- 136/02-900/..
- 155/01
- 155/21
- 155/41
- 167/02
- 167/02-900/..
- 168/02
- 168/02-900/..
- 195/02
- 195/02-900/..
- 195/04
- 226/02
- 226/02-900/..
- 248/02
- 248/02-900/..

91-026 745-04 ☐

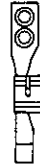

- 6/01
- 17/43
- 19/01
- 19/02
- 40/41
- 42/02
- 136/02
- 167/02
- 168/02
- 195/02
- 226/02
- 248/02

91-040 444-04 ☐ 12/2

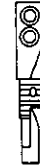

- 2/01
- 2/01-900/11; /51
- 40/11
- 40/11-900/11; /51
- 40/61
- 40/61-900/11; /51

91-040 897-04 ☐

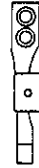

- 17/41
- 39/41
- 155/41

91-045 591-04 ☐ 12/2

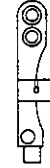

- 17/01
- 39/01
- 39/21
- 39/22
- 95/04
- 155/01
- 155/21
- 195/04

91-047 399-04 ☐



-39/81

91-047 822-04 ☐



- 6/01-900/..
- 17/43-900/..
- 19/01-900/..
- 19/02-900/..
- 40/41-900/..
- 42/02-900/..
- 136/02-900/..
- 167/02-900/..
- 168/02-900/..
- 195/02-900/..
- 226/02-900/..
- 248/02-900/..

91-026 746-04 ☐



- 6/01
- 17/43
- 19/01
- 19/02
- 40/41
- 42/02
- 136/02
- 167/02
- 168/02
- 195/02
- 226/02
- 248/02

91-040 445-04 ☐ 12/2



- 2/01
- 40/11
- 40/61

91-040 898-04 ☐



- 17/41
- 39/41
- 155/41

91-045 592-04 ☐



- 17/01
- 39/01
- 39/21
- 39/22
- 95/04
- 155/01
- 195/04

91-048 360-04 ☐



-155/21

91-048 924-04 ☐



-39/81

91-058 420-05



- 6/01-900/11; /51
- 17/43-900/11; /51
- 19/01-900/11; /51
- 19/02-900/11; /51
- 40/41-900/11; /51
- 42/02-900/11; /51
- 136/02-900/11; /51
- 167/02-900/11; /51
- 168/02-900/11; /51
- 195/02-900/11; /51
- 226/02-900/11; /51
- 248/02-900/11; /51

91-058 422-04 ☐



- 2/01-900/11; /51
- 40/11-900/11; /51
- 40/61-900/11; /51

91-058 939-05







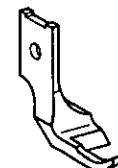



























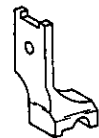









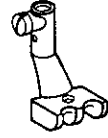



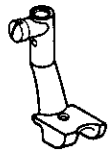

- 6/01-900/16; /56
- 17/43-900/16; /56
- 19/01-900/16; /56
- 19/02-900/16; /56
- 40/41-900/16; /56
- 42/02-900/16; /56
- 136/02-900/16; /56
- 167/02-900/16; /56
- 168/02-900/16; /56
- 195/02-900/16; /56
- 226/02-900/16; /56
- 248/02-900/16; /56

91-040 234-04 ☐ 12/2

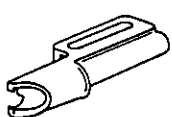

- 2/01
- 2/01-900/11; /51

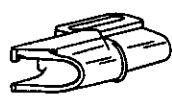
Unterklassen-Übersicht/Table of subclasses/Table des sous-classes/Tabla de subclasses

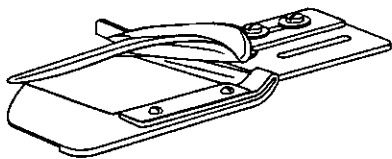
<p>91-040 432-04  </p>  <p>-17/01 -39/01 -39/81 -155/01</p>	<p>91-040 475-04  </p>  <p>-6/01 -40/41 -17/41 -40/41-900/.. -19/01 -155/41 -19/01-900/.. -167/02 -19/02 -167/02-900/.. -19/02-900/.. -195/02 -39/41 -195/02-900/..</p>	<p>91-042 180-04  </p>  <p>-168/02 -168/02-900/..</p>	<p>91-044 227-04  </p>  <p>-39/21 -40/61 -39/22 -40/61-900/11;/51 -40/11 -95/04 -40/11 -155/21 -900/11;/51 -195/04</p>
<p>91-046 342-04  </p>  <p>-42/02 -42/02-900/..</p>	<p>91-046 656-04 </p>  <p>-248/02 -248/02-900/..</p>	<p>91-046 719-04  </p>  <p>-226/02 -226/02-900/..</p>	<p>91-049 514-04  </p>  <p>-17/43 -17/43-900/.. -136/02 -136/02-900/..</p>
<p>91-040 233-93 </p>  <p>-2/01 -2/01-900/11;/51</p>	<p>91-040 461-93  </p>  <p>-42/02 -42/02-900/..</p>	<p>91-040 474-93  </p>  <p>-19/01-900/.. -19/02 -19/02-900/.. -39/41 -40/41 -40/41-900/.. -155/41 -167/02 -6/01 -167/02 -6/01-900/.. -167/02-900/.. -17/41 -195/02 -19/01 -195/02-900/..</p>	<p>91-042 181-93  </p>  <p>-168/02 -168/02-900/..</p>
<p>91-042 819-93  </p>  <p>-17/01 -40/11 -155/01 -39/01 -40/11-900/11;/51 -155/21 -39/21 -40/61 -195/04 -39/22 -40/61-900/11;/51 -39/81 -95/04</p>	<p>91-046 657-93 </p>  <p>-248/02 -248/02-900/..</p>	<p>91-046 720-93  </p>  <p>-226/02 -226/02-900/..</p>	<p>91-049 021-93  </p>  <p>-17/43 -17/43-900/.. -136/02 -136/02-900/..</p>
<p>91-040 533-23 </p> 	<p>91-040 600-23 </p> 	<p>91-040 638-23 </p>  <p>-42/02 -42/02-900/..</p>	

91-040 798-23 

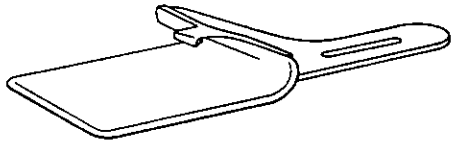

-195/02  
-195/02-900/..

91-041 006-23 

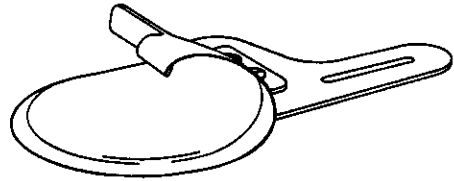

-19/01  
19/01-900/..

91-041 111-23 

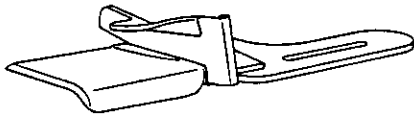

-17/41

91-041 112-23 

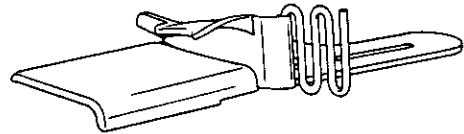

-155/41

91-041 113-23 

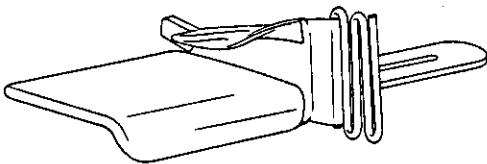

-39/41

91-041 382-23 

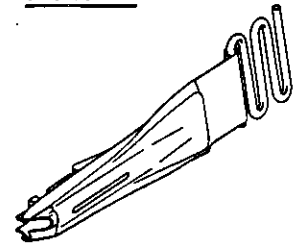

-39/21

91-041 959-23 

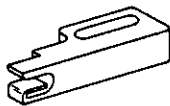

-95/04

91-041 969-25 

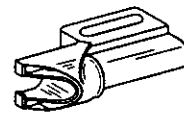

-39/01

91-041 991-25 



-195/04

91-042 099-23 

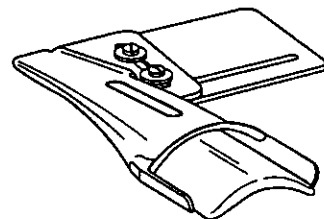

-167/02  
-167/02-900/..

Unterklassen-Übersicht/ Table of subclasses/ Table des sous-classes/ Tabla de subclasses

91-042 179-23 [5]

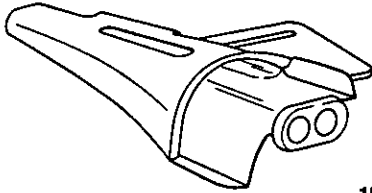

-168/02  
-168/02-900/..

91-043 921-24 [5]

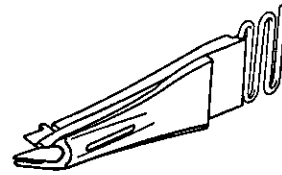

-155/21

91-044 408-23 [5]

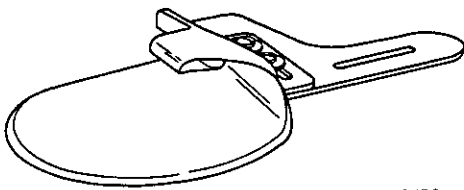

-19/02  
-19/02-900/..

91-046 265-25 [5]

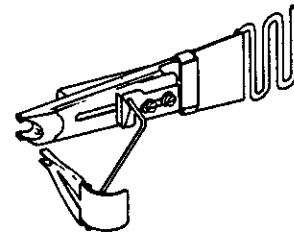

-39/22

91-046 331-24 [5]

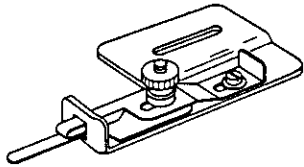

-40/61  
-40/61-900/11: /51

91-046 653-21 [5]



-248/02  
-248/02-900/..

91-046 721-25 [5]

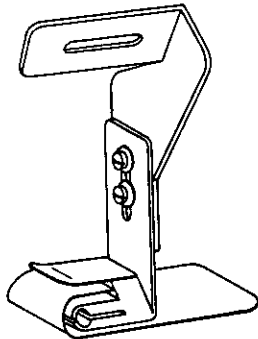

-226/02  
226/02-900/..

91-053 078-23 [5]

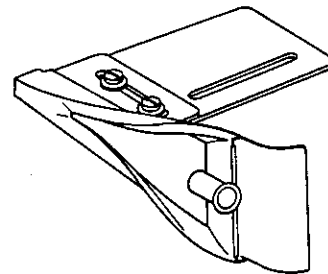

-136/02  
-136/02-900/..

91-053 132-25 [3]

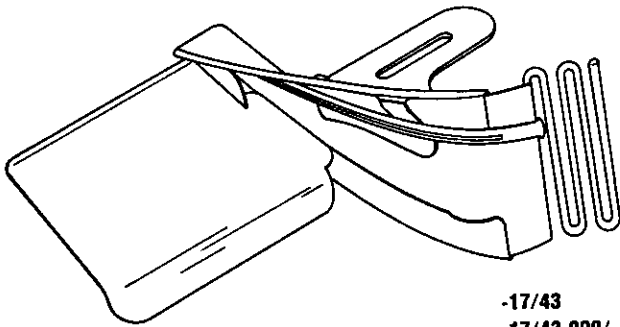

-17/43  
-17/43-900/..

91-053 257-93 [3]

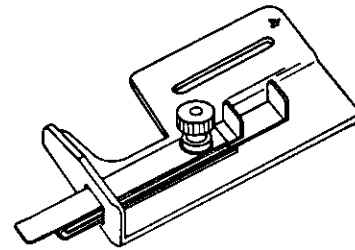

-40/41  
-40/41-900/..

91-053 674-23 [3]

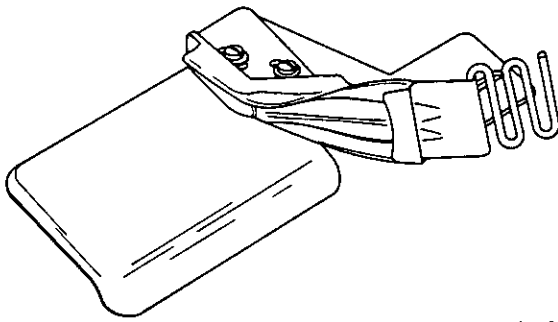

-39/81

91-053 676-25 [3]

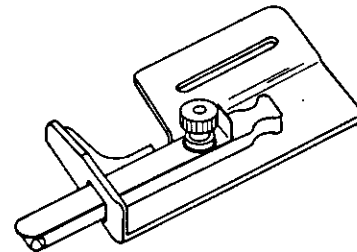

-40/11  
-40/11-900/11; /51

91-040 528-90

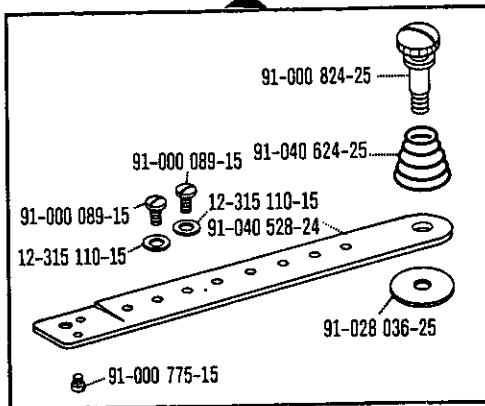

-17/41	-42/02-900/..
-17/43	-136/02
-17/43-900/..	-136/02-900/..
-19/01	-155/21
-19/01-900/..	-167/02
-19/02	-167/02-900/..
-19/02-900/..	-168/02
-39/41	-168/02-900/..
-39/81	-195/02
-42/02	-195/02-900/..

91-040 862-90

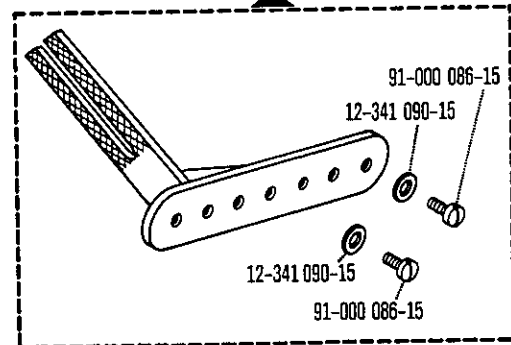

-226/02  
-226/02-900/..



Unterklassen-Übersicht/ Table of subclasses/ Table des sous-classes/ Tabla de subclases

91-042 940-90

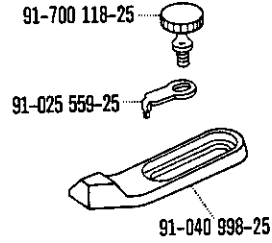
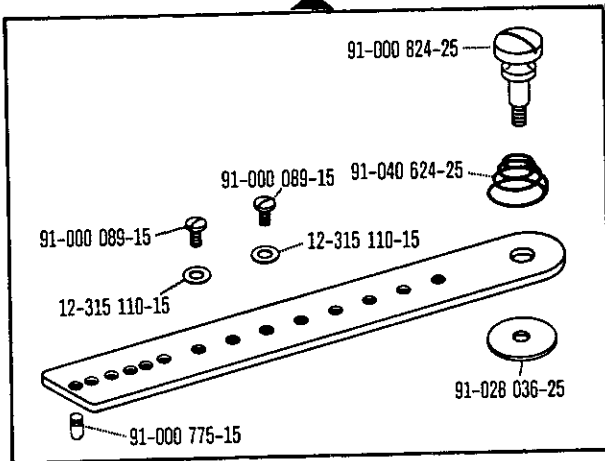

-40/11                      -40/61  
 -40/11-900/11; /51    -40/61-900/11; /51  
 -40/41                      -248/02  
 -40/41-900/..            -248/02-900/..

-2/01  
 -2/01-900/11; /51

91-045 607-90

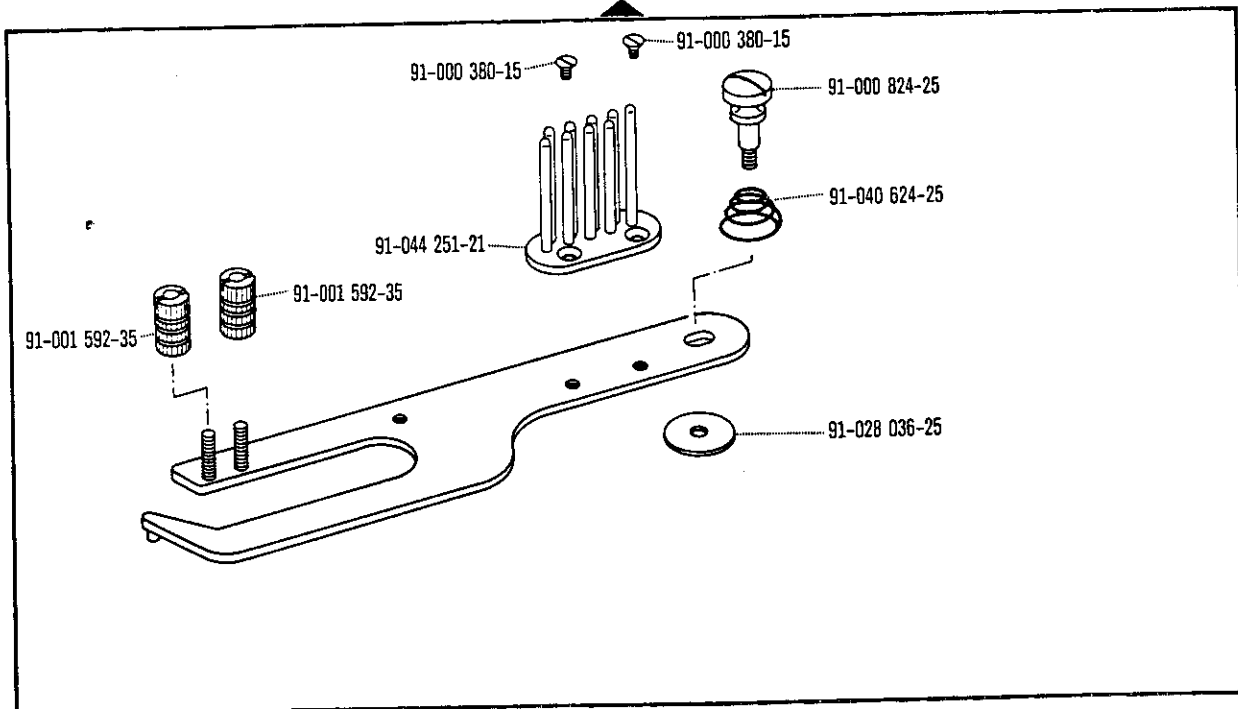

-17/01                      -95/04  
 -39/01                      -155/01  
 -39/21                      -155/21  
 -39/22                      -195/04

91-010 702-91

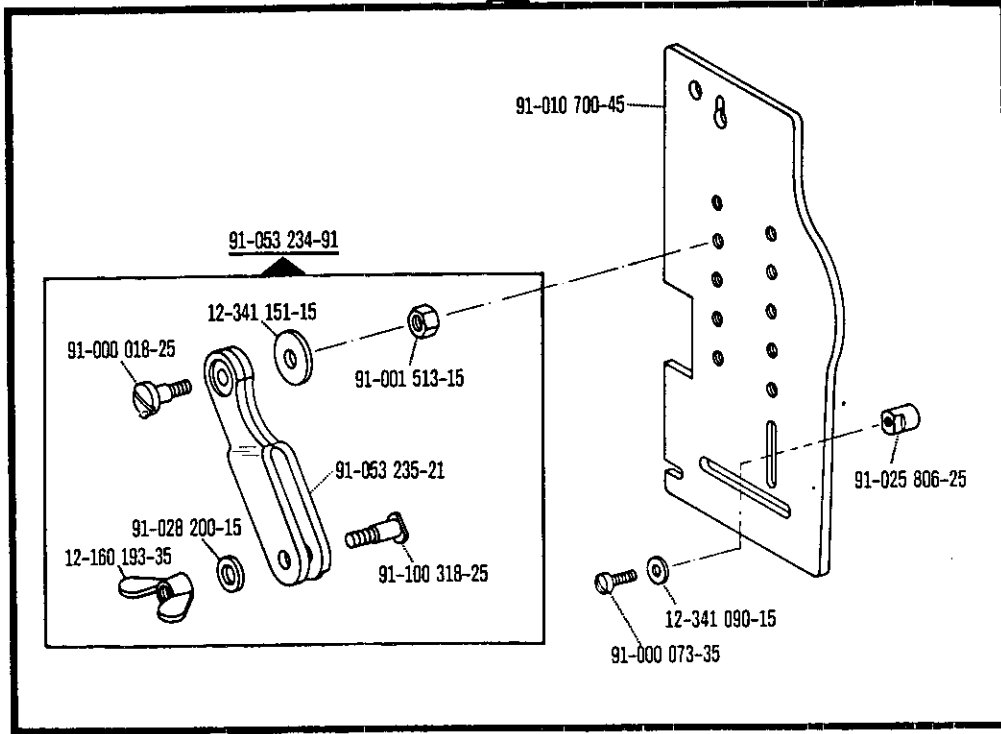

-226/02  
-226/02-900/..

91-043 938-91

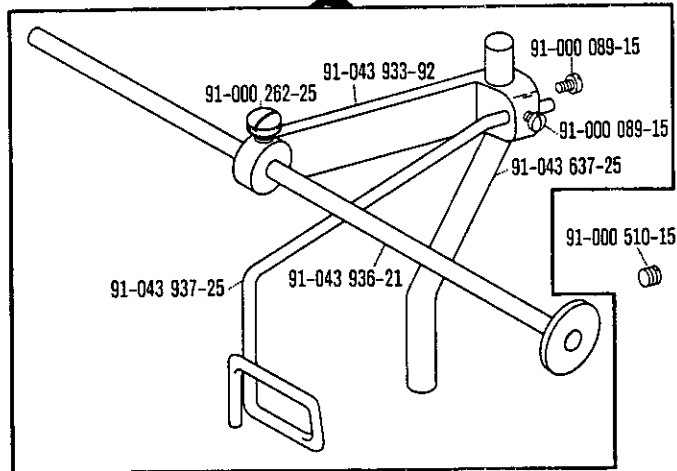

-226/02  
-226/02-900/.. 10

Unterklassen-Übersicht/Table of subclasses/Table des sous-classes/Tabla de subclases

91-043 943-91

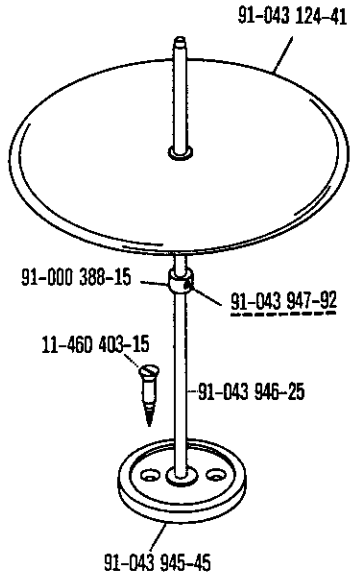

-17/01  
-17/41  
-39/01  
-39/21  
-39/22  
-39/41  
-39/81  
-155/01  
-155/21  
-155/41

91-010 625-24

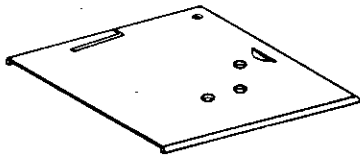

-40/11  
-40/41  
-40/61  
-248/02

91-492 006-25

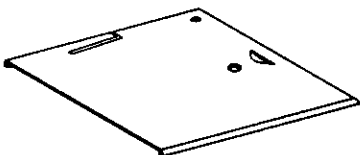

-40/11-900/11; /51  
-40/41-900/..  
-40/61-900/11; /51  
-248/02-900/..

91-055 203-91

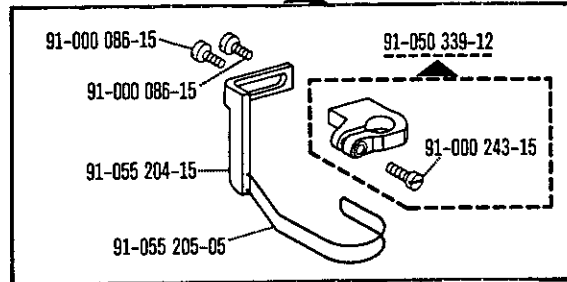

-2/01	-40/61
-2/01-900/11; /51	-40/61-900/11; /51
-6/01	-42/02
-6/01-900/..	-42/02-900/..
-17/01	-95/04
-17/41	-136/02
-17/43	-136/02-900/..
-17/43-900/..	-155/01
-19/01	-155/21
-19/01-900/..	-155/41
-19/02	-167/02
-19/02-900/..	-167/02-900/..
-39/01	-168/02
-39/21	-168/02-900/..
-39/22	-195/02
-39/41	-195/02-900/..
-39/81	-195/04
-40/11	-226/02
-40/11-900/11; /51	-226/02-900/..
-40/41	-248/02
-40/41-900/..	-248/02-900/..

# PFAFF

**G.M. PFAFF  
Aktiengesellschaft**

Postfach 3020  
D-67653 Kaiserslautern

Königstr. 154  
D-67655 Kaiserslautern

Telefon: (0631) 200-0  
Telefax: (0631) 172 02  
Telex: 45753 PFAFF D

Gedruckt in der BRD  
Printed in Germany  
Imprimé en R.F.A.  
Impreso en la R.F.A.