

PFAFF

1245

Unterklassen-Ausstattung

Subclass parts

Composition des sous-classes

Composición de las subclases

Erläuterungen
Explanations

Légende
Explicaciones

Die Liste enthält nur Nähwerkzeuge sowie unterklassenabhängige Teile. Beim Umbau in eine andere Unterklasse bzw. Ausführung können auch noch Maschinenteile erforderlich sein. Geben Sie also bei Bestellungen die genaue Bezeichnung der vorhandenen bzw. der gewünschten Ausführung an.

The list contains only gauge parts and subclass-dependent parts. For a conversion into another subclass or version machine parts may be required as well. Please state the exact classification of the existing or required version on your order.

La liste comprend uniquement des organes de couture et des pièces dépendant des sous-classes. En cas de transformation en une autre sous-classe ou une autre version, il se peut que d'autres pièces de machine soient nécessaires. C'est pourquoi nous vous prions d'indiquer, à la commande, la désignation exacte de la version existante ou souhaitée.

La lista contiene solamente órganos de costura y piezas dependientes de la subclase. En el caso de transformación en otra subclase o en otro tipo, es posible que sean necesarias piezas de la máquina. Al hacer los pedidos, indíquese la denominación exacta del tipo existente o del deseado.

- 4** Ausführungsart bei Bestellung angeben.
Model to be stated on order.
Préciser le modèle à la commande.
Indíquese el tipo en los pedidos.
- 5** Nähmuster bzw. Material einsenden.
Submit sewing sample or material.
Joindre échantillons de couture ou matières.
Enviense muestras de costura.
- 12/2** Absteppbreite bei Bestellung angeben.
Stitching margin to be stated on order.
Indiquer le relarge de couture à la commande.
Indíquese el margen de costura en los pedidos.
- 38/11** Ohne Zahnung
Without teeth
Sans denture
S'in dentado
- 95/8** X-Werte bei Bestellung angeben.
Please state x-values on order.
Indiquer les valeurs "x" à la commande.
Indíquese en los pedidos los valores "x".
- (P) Hüpftransport, auf Wunsch lieferbar.
Four motion drop feed, available on request.
Griffe sautillante, en option.
Transportador a cuatro tiempos, sobre demanda.
- * Mit Hüpftransport (P) nicht lieferbar.
Not available with four motion drop feed (P).
Non livrable avec griffe sautillante (P).
No suministra co transportador a cuatro tiempos (P).

Unterklassen-Übersicht
Table of subclasses

Table des sous-classes
Tabla de subclasses

Unterklasse Subclass Sous-classe Subclase	-706/07 (P)-2/01	-706/07 (P)-6/01	-706/07 (P)-6/01	-706/07 (P) -6/01-900/..	-706/07 (P) -6/01-900/..
Arbeitsgang Operation Opération Operación	Für rechte Kantennäharbeiten. Standardform des Teilesatzes. Lineal auf der Grundplatte befestigt. For right-hand marginal stitching operations. Standard part set. Edge guide mounted on bedplate. Piqûres longeant les bords. Jeu de pièces standard. Guide-bord monté sur le plateau fondamental. Para el cosido de orillas o cantos. Juego de piezas estándar. Guía sobre la placa base.	Für allgemeine Näharbeiten. Standardform des Teilesatzes. For ordinary sewing operations. Standard part set. Travaux d'utilité courante. Jeu de pièces standard. Para trabajos de costura en general. Juego de piezas estándar.	Für allgemeine Näharbeiten. Standardform des Teilesatzes. For ordinary sewing operations. Standard part set. Travaux d'utilité courante. Jeu de pièces standard. Para trabajos de costura en general. Juego de piezas estándar.	Für allgemeine Näharbeiten. Standardform des Teilesatzes. For ordinary sewing operations. Standard part set. Travaux d'utilité courante. Jeu de pièces standard. Para trabajos de costura en general. Juego de piezas estándar.	Für allgemeine Näharbeiten. Standardform des Teilesatzes. For ordinary sewing operations. Standard part set. Travaux d'utilité courante. Jeu de pièces standard. Para trabajos de costura en general. Juego de piezas estándar.
Ausführung Model Version Tipo de máquina	CN	CN	CN 8	CN	CN 8
Nadelstange Needle bar Barre à aiguille Barra de aguja	91-140 071-91	91-140 071-91	91-140 071-91	91-140 071-91	91-140 071-91
Stoffschieber ⁴ Feed dog Griffe Transportador inferior	91-040 444-04 ¹²²	91-047 933-04	91-026 745-04	91-047 933-04	91-047 933-04
Stichplatte ⁴ Needle plate Plaque à aiguille Placa de aguja	91-040 445-04 ¹²²	91-048 537-05	91-048 922-04	91-058 868-05	91-158 549-05
Stoffdrückerfuß ⁴ ¹²² Presser foot Pied presseur Pie prensatelas	91-049 714-04	91-040 475-04	91-049 585-04	91-040 475-04	91-049 585-04
Stoffschiebefuß ⁴ ¹²² Vibrating presser Pied entralneur Transportador superior	91-040 233-93	91-049 269-93	91-049 269-93	91-049 269-93	91-049 269-93
Fingerschutz Finger guard Protège-doigts Salvadedos	91-057 721-91	91-057 721-91	91-057 741-91	91-057 721-91	91-057 741-91
Lineal Edge guide Guide-bord Guía recta	91-040 998-25				
Schieber, links Slide, left Glissière, gauche Corredera, izquierda	91-009 308-25	91-009 308-25	91-009 308-25	91-018 889-24 x 0,8 ^{95/8}	91-018 889-24 x 0,8 ^{95/8}
Schieber, rechts ^{95/8} Slide, right Glissière, droite Corredera, derecha	91-010 061-24 x 0,8	91-010 061-24 x 0,8	91-010 061-24 x 0,8	91-018 888-24 x 0,8	91-018 888-24 x 0,8

Unterklassen-Übersicht
Table of subclasses

Table des sous-classes
Tabla de subclasses

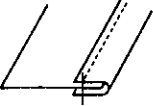
Unterklasse Subclass Sous-classe Subclase	-706/07 (P)-6/07	-706/07 (P)-6/07	-706/07 (P) -6/07-900/..	-706/07 (P) -6/07-900/..	-706/07-17/01*
Arbeitsgang Operation Opération	Für Nähte mit Übergängen (Kletterteilesatz). For seams involving cross seams (climbing parts set). Couture de matières à surépaisseurs (piéd grim pant). Para costuras con desniveles (juego de piezas trepador).	Für Nähte mit Übergängen (Kletterteilesatz). For seams involving cross seams (climbing parts set). Couture de matières à surépaisseurs (piéd grim pant). Para costuras con desniveles (juego de piezas trepador).	Für Nähte mit Übergängen (Kletterteilesatz). For seams involving cross seams (climbing parts set). Couture de matières à surépaisseurs (piéd grim pant). Para costuras con desniveles (juego de piezas trepador).	Für Nähte mit Übergängen (Kletterteilesatz). For seams involving cross seams (climbing parts set). Couture de matières à surépaisseurs (piéd grim pant). Para costuras con desniveles (juego de piezas trepador).	
Ausführung Model Version Tipo de máquina	CN	CN 8	CN	CN 8	CN
Nadelstange Needle bar Barre à aiguille Barra de aguja	91-140 679-92	91-140 679-92	91-140 679-92	91-140 679-92	91-140 071-91
Stoffschieber ^[4] Feed dog Griffe Transportador inferior	91-047 933-04	91-026 745-04	91-047 933-04	91-047 933-04	91-045 591-04
Stichplatte ^[4] Needle plate Plaque à aiguille Placa de aguja	91-048 537-05	91-048 922-04	91-058 868-05	91-158 549-05	91-045 592-04
Stoffdrückfuß ^[4] Presser foot Piéd presseur Pie prensatejas	91-049 792-04 x 3,2 ^[95/8]	91-049 792-04 x 3,2 ^[95/8]	91-049 792-04 x 3,2 ^[95/8]	91-049 792-04 x 3,2 ^[95/8]	91-040 432-04 ^[12/2]
Stoffschiebefuß ^[4] Vibrating presser Piéd entraîneur Transportador superior	91-049 345-93	91-049 345-93	91-049 345-93	91-049 345-93	91-042 819-93 ^[12/2] ^[98/11]
Fingerschutz Finger guard Protège-doigts Salvadedos	91-057 806-91	91-057 806-91	91-057 806-91	91-057 809-91	91-057 721-91
Apparat ^[5] Attachment Appareil Aparato					91-040 533-23
Träger Bracket Support Soporto					91-045 607-90 x 13 ^[95/8]
Bandteiler Tape disc Plateau dérouleur Plato portacintas					91-043 943-70/895
Schieber, links Slide, left Glissière, gauche Corredera, izquierda	91-009 308-25	91-009 308-25	91-018 889-24 x 0,8 ^[95/8]	91-018 889-24 x 0,8 ^[95/8]	91-009 308-25
Schieber, rechts ^[95/8] Slide, right Glissière, droite Corredera, derecha	91-010 061-24 x 0,8	91-010 061-24 x 0,8	91-018 888-24 x 0,8	91-018 888-24 x 0,8	91-010 061-24 x 0,8

Unterklassen-Übersicht
Table of subclasses

Table des sous-classes
Tabla de subclasses

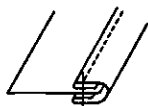
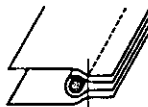
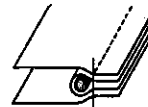
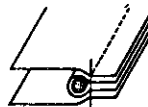
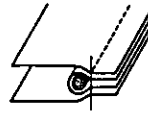
Unterklasse Subclass Sous-classe Subclase	-706/07-39/21*	-706/07 (P)-40/01	-706/07 (P)-40/01	-706/07 (P) -40/01-900/..	-706/07 (P) -40/01-900/..
Arbeitsgang Operation Opération Opération					
Ausführung Model Version Tipo de máquina	CN	CN	CN 8	CN	CN 8
Nadelstange Needle bar Barre à aiguille Barra de aguja	91-140 071-91	91-140 071-91	91-140 071-91	91-140 071-91	91-140 071-91
Stoffschieber ⁴ Feed dog Griffe Transportador inferior	91-045 591-04	91-026 745-04	91-026 745-04	91-047 933-04	91-047 933-04
Stichplatte ⁴ Needle plate Plaque à aiguille Placa de aguja	91-045 592-04	91-026 746-04	91-048 922-04	91-058 868-05	91-058 868-05
Stoffdrückerfuß ⁴ ¹²² Presser foot Pied presseur Pie prensatelas	91-040 432-04	91-044 102-04 ⁵ ^{38/11}	91-044 102-04 ⁵ ^{38/11}	91-044 102-04 ⁵ ^{38/11}	91-044 102-04 ⁵ ^{38/11}
Stoffschieberfuß ⁴ ¹²² Vibrating presser Pied entraîneur Transportador superior	91-042 819-93 ^{38/11}	91-044 101-93 ⁵	91-044 101-93 ⁵	91-044 101-93 ⁵	91-044 101-93 ⁵
Fingerschutz Finger guard Protège-doigts Salvadedos	91-057 721-91	91-057 721-91	91-057 721-91	91-057 721-91	91-057 721-91
Apparat ⁵ Attachment Appareil Aparato	91-041 382-23	91-046 330-93	91-046 330-93	91-046 330-93	91-046 330-93
Träger Bracket Support Soporto	91-045 607-90 x 13 ^{85/8}	91-042 940-90	91-042 940-90	91-042 940-90	91-042 940-90
Bandteller Tape disc Plateau dérouleur Plato portacintas	91-043 943-70/895				
Schieber, links Slide, left Glissière, gauche Corredera, izquierda	91-009 308-25	91-009 308-25	* 91-009 308-25	91-018 889-24 x 0,8 ^{85/8}	91-018 889-24 x 0,8 ^{85/8}
Schieber, rechts ^{85/8} Slide, right Glissière, droite Corredera, derecha	91-010 061-24 x 0,8	91-010 625-24 x 0,8	91-010 625-24 x 0,8	91-492 006-24 x 0,8	91-492 006-24 x 0,8

Unterklassen-Übersicht
Table of subclasses

Table des sous-classes
Tabla de subclasses

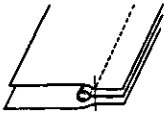
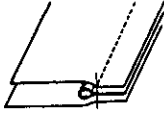
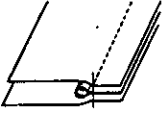
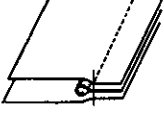
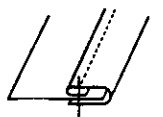
Unterklasse Subclass Sous-classe Subclase	-706/07 (P)-40/05	-706/07 (P)-40/05	-706/07 (P) -40/05-900/..	-706/07 (P) -40/05-900/..	-706/07 (P)-155/01*
Arbeitsgang Operation Opération Operación					
Ausführung Model Version Tipo de máquina	CN	CN 8	CN	CN 8	CN
Nadelstange Needle bar Barre à aiguille Barra de aguja	91-140 071-91	91-140 071-91	91-140 071-91	91-140 071-91	91-140 071-91
Stoffschieber ⁴ Feed dog Griffe Transportador inferior	91-026 745-04	91-026 745-04	91-047 933-04	91-047 933-04	91-045 591-04
Stichplatte ⁴ Needle plate Plaque à aiguille Placa de aguja	91-026 746-04	91-048 922-04	91-058 868-05	91-158 549-05	91-045 592-04
Stoffdrückerfuß ^{4 5 12/2} Presser foot ^{38/11} Pied presseur Pie prensateelas	91-044 102-04	91-044 102-04	91-044 102-04	91-044 102-04	91-040 432-04
Stoffschiebefuß ^{4 5 12/2} Vibrating presser ^{38/11} Pied entraîneur Transportador superior	91-044 101-93	91-044 101-93	91-044 101-93	91-044 101-93	91-042 819-93
Fingerschutz Finger guard Protège-doigts Salvadedos	91-057 721-91	91-057 721-91	91-057 721-91	91-057 721-91	91-057 721-91
Apparat ⁵ Attachment Appareil Aparato	91-053 256-93	91-053 256-93	91-053 256-93	91-053 256-93	91-040 600-23
Träger Bracket Support Soporto	91-042 940-90	91-042 940-90	91-042 940-90	91-042 940-90	91-045 607-90 x 13 ^{95/8}
Schieber, links Slide, left Glissière, gauche Corredera, izquierda	91-009 308-25	91-009 308-25	91-018 889-24 x 0,8 ^{95/8}	91-018 889-24 x 0,8 ^{95/8}	91-009 308-25
Schieber, rechts ^{95/8} Slide, right Glissière, droite Corredera, derecha	91-010 625-24 x 0,8	91-010 625-24 x	91-492 006-24 x 0,8	91-492 006-24 x 0,8	91-010 061-24 x 0,8
Bandtailer Tape disc Plateau dérouleur Plato portacintas					91-043 943-70/895

Unterklassen-Übersicht
Table of subclasses

Table des sous-classes
Tabla de subclasses

Unterklasse Subclass Sous-classe Subclass	-706/47 (P)-6/01
Arbeitsgang Operation Opération Operación	Für allgemeine Näharbeiten. Standardform des Teilesatzes. For ordinary sewing operations. Standard part set. Travaux d'utilité courante. Jeu de pièces standard. Para trabajos de costura en general. Juego de piezas estándar.
Ausführung Model Version Tipo de máquina	CN
Nadelstange Needle bar Barre à aiguille Barra de aguja	91-140 071-91
Stoffschieber [4] Feed dog Griffe Transportador inferior	91-047 933-04
Stichplatte [4] Needle plate Plaque à aiguille Placa de aguja	91-048 537-05
Stoffrückenfuß [4] Presser foot Pied presseur Pie prensatelas	91-040 475-04 [12/2]
Stoffschiebefuß [4] [12/2] Vibrating presser Pied entraîneur Transportador superior	91-049 269-93
Fingerschutz Finger guard Protège-doigts Salvadedos	91-057 721-91
Apparat [5] Attachment Appareil Aparato	
Träger Bracket Support Soporto	
Blattfeder Leaf spring Ressort-lame Muelle de láminas	
Schieber, links Slide, left Glissière, gauche Corredera, izquierda	91-009 308-25
Schieber, rechts [95/8] Slide, right Glissière, droite Corredera, derecha	91-010 061-24 x 0,8

Nähwerkzeuge
Gauge parts

Organes de couture
Organos de costura

91-140 071-91

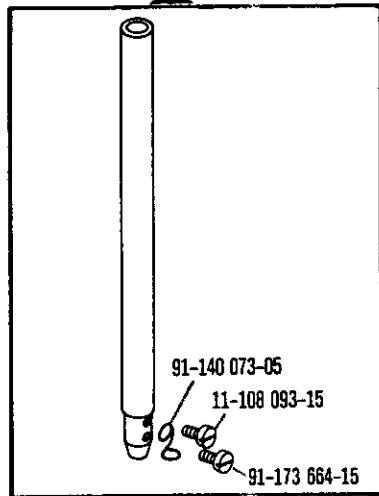

91-140 679-92

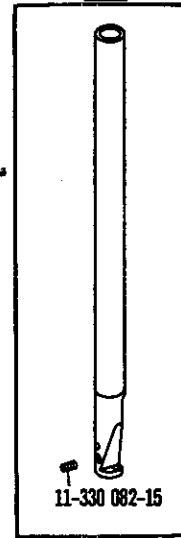

- 706/07-2/01
- 706/07-6/01 (-900/..)
- 706/07-17/01
- 706/07-39/21
- 706/07-40/01 (-900/..)
- 706/07-40/05 (-900/..)
- 706/07-155/01
- 706/47-6/01

-706/07-6/07 (-900/..)

91-026 745-04



- 706/07-6/01 CN 8
- 706/07-6/07 CN 8
- 706/07-40/01
- 706/07-40/05

91-040 444-04



-706/07-2/01

91-045 591-04

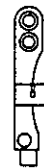

- 706/07-17/01
- 706/07-39/21
- 706/07-155/01

91-047 933-04



- 706/07-6/01 (-900/..)
- 706/07-6/01-900/.. CN 8
- 706/07-6/07 (-900/..)
- 706/07-6/07-900/.. CN 8
- 706/07-40/01-900/..
- 706/07-40/05-900/..
- 706/47-6/01

Nähwerkzeuge
Gauge parts

Organes de couture
Organos de costura

91-026 746-04 [4]

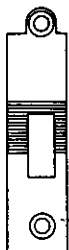

-706/07-40/01
-706/07-40/05

91-040 445-04 [4] [12/2]



-706/07-2/01

91-045 592-04 [4]



-706/07-17/01
-706/07-39/21
-706/07-155/01

91-048 537-05 [4]



-706/07-6/01
-706/07-6/07
-706/47-6/01

91-048 922-04 [4]



-706/07-6/01 CN 8
-706/07-6/07 CN 8
-706/07-40/01 CN 8
-706/07-40/05 CN 8

91-058 868-05 [4]



-706/07-6/01-900/..
-706/07-6/07-900/..
-706/07-40/01-900/..
-706/07-40/05-900/..

91-158 549-05



-706/07-6/01-900/.. CN 8
-706/07-6/07-900/.. CN 8
-706/07-40/05-900/.. CN 8

91-040 432-04 [4] [12/2]



-706/07-17/01
-706/07-39/21
-706/47-155/01

91-040 475-04 [4] [12/2]



-706/07-6/01 (-900/..
-706/47-6/01

91-044 102-04 [4] [5] [12/2] [36/11]



-706/07-40/01 (-900/..
-706/07-40/05 (-900/..
-706/07-40/09 (-900/..)

91-049 585-04 [4]

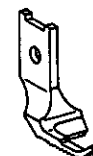

-706/07-6/01 (-900/..) CN 8

Nähwerkzeuge
Gauge parts

Organes de couture
Organos de costura

91-049 714-04 [4] [12/2]

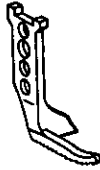

-706/07-2/01

91-049 792-04 x 3,2 [4] [6/8]

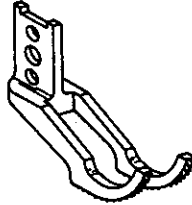

-706/07-6/07 (-900/..)

91-040 233-93 [4] [12/2]

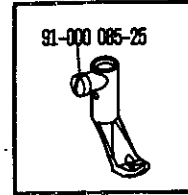

-706/07-2/01

91-042 819-93 [4] [12/2] [38/11]



-706/07-17/01
-706/07-39/21
-706/07-155/01

91-044 101-93 [4] [5] [12/2] [38/11]

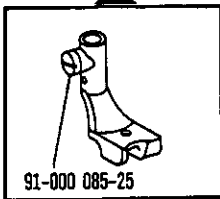

-706/07-40/01 (-900/..)
-706/07-40/05 (-900/..)

91-049 269-93 [4] [12/2]

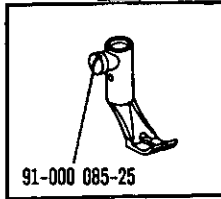

-706/07-6/01 (-900/..)
-706/47-6/01

91-049 345-93 [4]

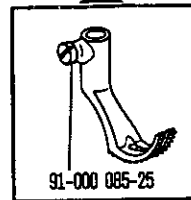

-706/07-6/07 (-900/..)

11-108 222-15 (2 x)

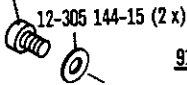

91-057 721-91

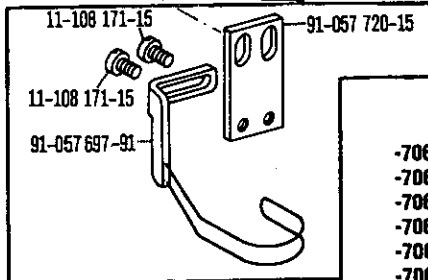

-706/07-2/01
-706/07-6/01 (-900/..)
-706/07-17/01
-706/07-39/21
-706/07-40/01 (-900/..)
-706/07-40/05 (-900/..)
-706/07-155/01
-706/47-6/01

11-108 222-15 (2 x)

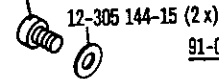

91-057 741-91

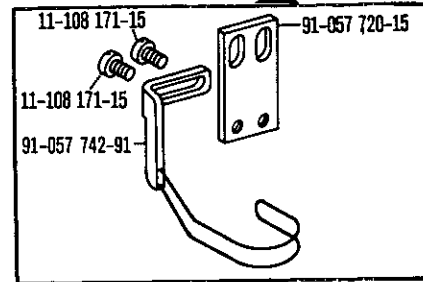

-706/07-6/01 (-900/..) CM 8

11-108 222-15



91-057 806-91

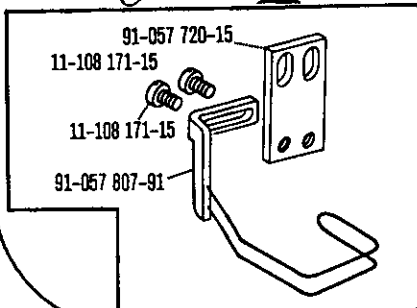

-706/07-6/07 (-900/..)

11-108 222-15



91-057 809-91

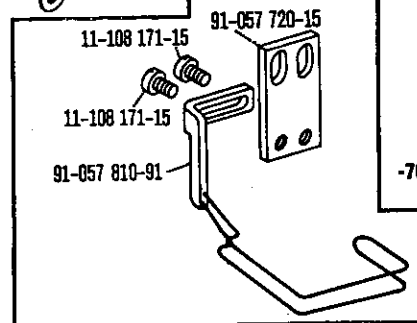

-706/07-6/07-900/.. CM 8

Nähwerkzeuge
Gauge parts

Organes de couture
Organos de costura

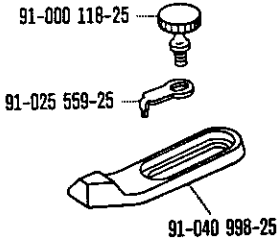

-706/07-2/01

91-040 533-23 [E]

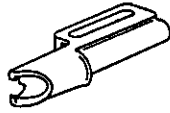

-706/07-17/01

91-040 600-23 [E]



-706/07-155/01

91-041 382-23 [E]

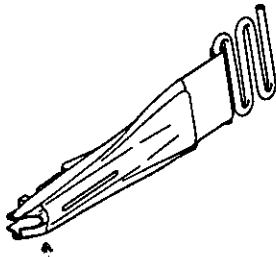

-706/07-39/21

91-046 330-93 [E]

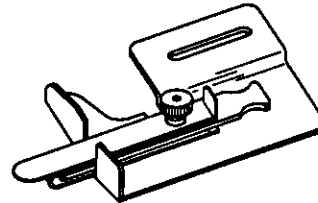

-706/07-40/01 (-900/..)

91-053 256-93 [E]

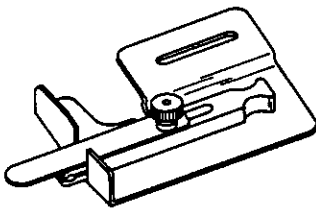

-706/07-40/05 (-900/..)

91-042 940-90

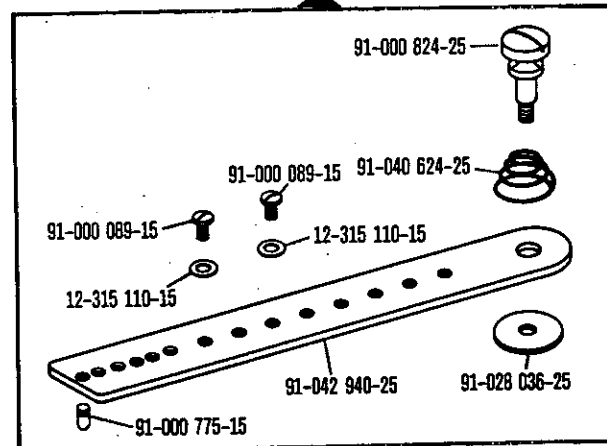

-706/07-40/01 (-900/..)
-706/07-40/05 (-900/..)

**Nähwerkzeuge
Gauge parts**

**Organes de couture
Organos de costura**

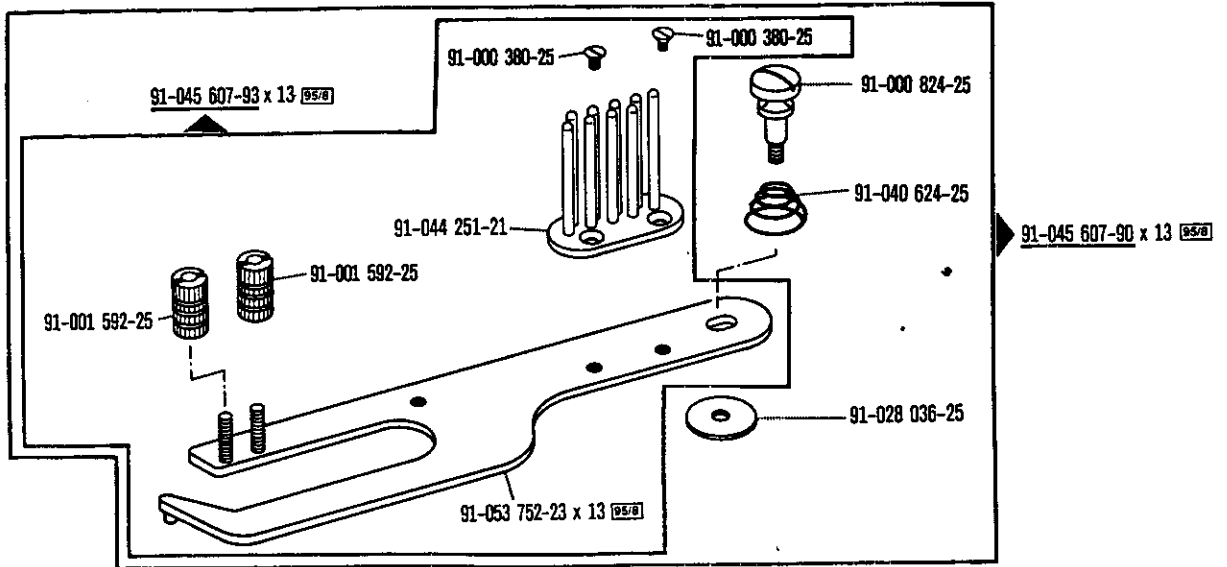

-706/07-17/01
-706/07-39/21
-706/07-155/01

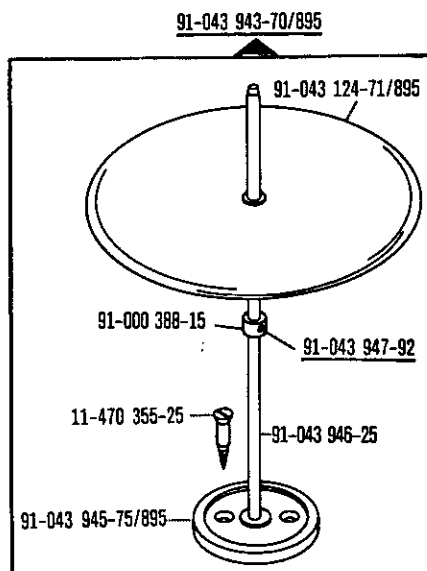

-706/07-17/01
-706/07-39/21
-706/07-155/01

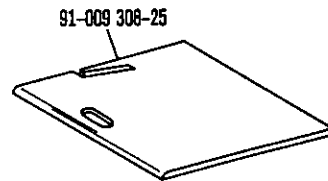

-706/07-2/01
-706/07-6/01
-706/07-6/07
-706/07-17/01
-706/07-39/21
-706/07-40/01
-706/07-40/05
-706/07-155/01
-706/47-6/01

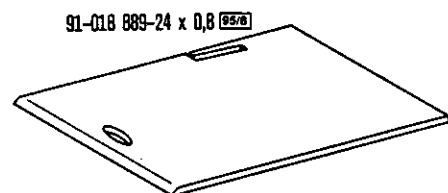



-706/07-6/01-900/..
-706/07-6/07-900/..
-706/07-40/01-900/..
-706/07-40/05-900/..

**Nähwerkzeuge
Gauge parts**

**Organes de couture
Organos de costura**

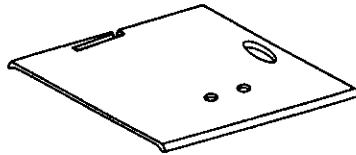
91-010 061-24 x 0,8 



91-010 625-24 x 0,8 

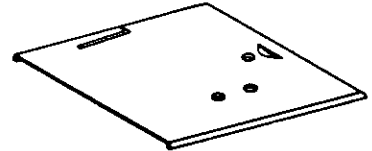

-706/07-2/01
-706/07-6/01
-706/07-6/07
-706/07-17/01
-706/07-39/21
-706/07-155/01
-706/47-6/01

-706/07-40/1
-706/07-40/1

91-018 888-24 x 0,8 

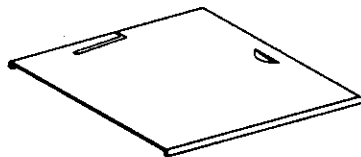

91-492 006-24 x 0,8 

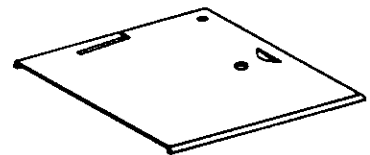

-706/07-6/01-900/..
-706/07-6/07-900/..

-706/07-40/01-900/..
-706/07-40/05-900/..

PFAFF